

## CLOCK

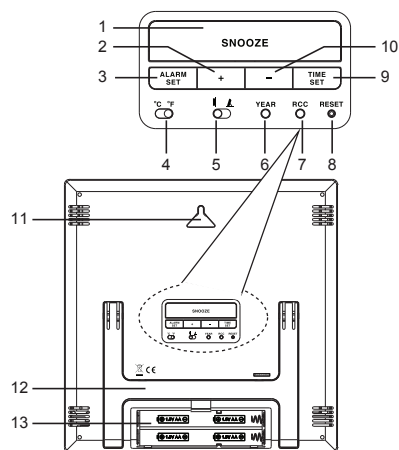

- |                                      |                        |
|--------------------------------------|------------------------|
| 1. [ SNOOZE ] button                 | 8. [ RESET ] button    |
| 2. [ + ] button                      | 9. [ TIME SET ] button |
| 3. [ ALARM SET ] button              | 10. [ - ] button       |
| 4. < °C/°F > slide switch            | 11. Wall-mounting hole |
| 5. < 1/∞ > Visual angle slide switch | 12. Table stand        |
| 6. [ YEAR ] button                   | 13. Battery door       |
| 7. [ RCC ] button                    |                        |

## DISPLAY

### Normal time mode

- AM/PM (12 Hour format)
- Time
- Date-Month / Year (DCF/MSF)  
Month-Date / Year (WWVB/JJY)
- Temperature
- Humidity
- Weekday
- Signal strength indicator
- Low battery indicator
- DST
- Time zone indicator (WWVB only)

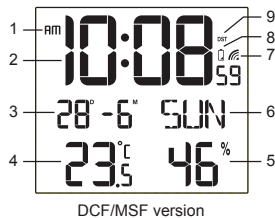

DCF/MSF version

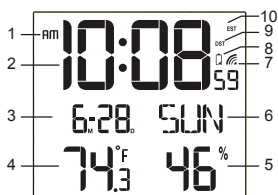

WWVB version

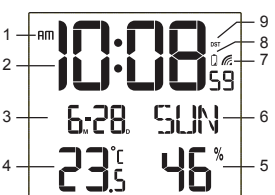

JJY version

### Alarm time mode

- Alarm time
- Alarm icon/Alarm on
- Alarm mode indicator

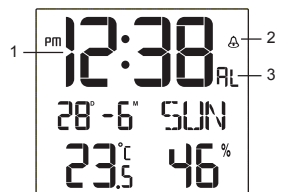

## GETTING STARTED

- Remove the battery door.
- Insert 4 new AA size batteries according to the “+/-” polarity mark on the battery compartment.
- Replace the battery door.
- Once the batteries are inserted, full segment of the LCD will be shown before entering the radio controlled time reception mode.
- The RC clock will automatically start scanning for the radio controlled time signal in 8 seconds.

### NOTE:

If no display appears on the LCD after inserting the batteries, press the [ RESET ] button by using a metal wire. In some cases, you may not receive the signal immediately. Due to the atmospheric disturbance, the best reception often occurs during nighttime.

## DAYLIGHT SAVING TIME (DST)

The clock will automatically advance the time by one hour in the spring and back an hour in the fall, provided that the DST function is not turned off. DST function is set to AUTO by default.

## RECEPTION OF RADIO CONTROLLED SIGNAL

This RC clock includes a built-in receiver which picks up the signal from the DCF/MSF/WWVB/JJY station. Therefore, the clock automatically sets the time, date and weekday.

- The clock automatically carries out four periodic synchronization procedures (at 2:00 AM, 8:00 AM, 2:00 PM and 8:00 PM daily) with the RC signal to correct any deviations to the exact time.
- Once the unit synchronizes successfully to the RC signal, the signal icon “” will show up. Each synchronization process will take between 6 to 16 minutes.
- To manually start or stop the RC signal reception, press [ RCC ] button.

### NOTE:

- The strength of radio-controlled time signal from the transmitter tower may be affected by geographical location or building around.
- Always place the unit away from interfering sources such as TV set, computer, etc.
- Avoid placing the unit on or next to metal plates.
- Closed areas such as airport, basement, tower block, or factory are not recommended.

## SIGNAL RECEPTION INDICATOR

The signal indicator displays signal strength in 4 levels. Wave segment flashing means time signals are being received. The signal quality could be classified into 4 types:

- RC synchronize process
- Weak signal quality
- Acceptable signal quality
- Excellent signal quality

## SWITCH THE RCC SIGNAL FREQUENCY (JJY VERSION ONLY)

During reception period, press and hold [ RCC ] button for 3 seconds to switch between 40KHz and 60KHz.

## TIME ZONE SETTING (WWVB VERSION ONLY)

Your clock is designed to display time for different time zones. Please refer to the **SETTING THE TIME AND CALENDAR** section to set your desired time zone in following order:

PST (Pacific) → MST (Mountain) → CST (Central) → EST (Eastern) → AST (Alaska) → NST (Northern)

## DISABLE / ENABLE RCC SIGNAL RECEPTION

- Press and hold [ RCC ] button for 8 seconds to disable the reception.
- Press and hold [ RCC ] button for 8 seconds to enable automatic RCC reception.

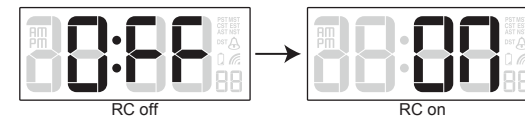

## SETTING THE TIME AND CALENDAR

- In normal time mode, press and hold [ TIME SET ] button for 2 seconds until the 12/24 Hr flashes.
- Press [ +/- ] button to set 12/24 Hour format.
- Press [ TIME SET ] button again until Hour digit flashes and press [ +/- ] button to adjust its value.
- Repeat above operations to set the time and calendar in this sequence:  
DCF/MSF version:  
 12/24Hr>Hour>Minute>Second>Year>Month>Date>+/-23 Hour offset  
 >Language>DST auto/off  
JJY version:  
 12/24Hr>Hour>Minute>Second>Year>Month>Date>+/-23 Hour offset  
 >Language>DST auto/off  
WWVB version:  
 12/24Hr>Time Zone>Hour>Minute>Second>Year>Month>Date>  
 +/-23 Hour offset >Language>DST auto/off
- Press [ TIME SET ] button to save the setting and return to normal time mode. Or the clock will automatically exit the setting mode after 1 minute without pressing any button.

### NOTE:

- When setting second, press [ +/- ] button to set its value to 00.
- 7 selectable languages and setting orders: EN(English) → FR(French) → DE(German) → ES(Spanish) → IT(Italian) → NL(Dutch) → RU(Russian)

## SETTING THE ALARM TIME

- In normal time mode, press and hold [ ALARM SET ] button for 2 seconds until Hour digit flashes.
- Press [ +/- ] button to set its value.
- Press [ ALARM SET ] button again to step to Minute setting. Press [ +/- ] button to set its value.
- Press [ ALARM SET ] button to save the setting and return to normal time mode. Or the clock will automatically exit the setting mode after 1 minute without pressing any button.

### NOTE:

After pressing [ +/- ] button, alarm function is automatically turned on (icon “” displayed).

## USING THE ALARM AND SNOOZE

- In normal time mode, press [ ALARM SET ] button to enter alarm time mode. Press [ ALARM SET ] button again to turn on (icon “” displayed) or turn off alarm function.

If alarm is turned on, alarm beeps at the alarm time.

Alarm beeping can be stopped by:

- Auto stop if no button is pressed during alarm sound beeping. Alarm beeping lasts for 2 minutes.
- Press [ SNOOZE ] button to stop the current alarm and enter snooze. Alarm icon will be flashing continuously. The alarm will sound again in 5 minutes. Snooze can be operated continuously in 24 hours.
- Press [ ALARM SET ] button to turn off alarm function.

## TEMPERATURE AND HUMIDITY DISPLAY

Slide the <°C/°F> switch to select the temperature unit °C or °F.

The temperature and humidity will display “Hi/Lo/---” on the conditions in the following chart:

Area	Condition	Display
Temperature	Temperature<-40°C	Lo
	Temperature>70°C	HI
Humidity	Humidity<20%	Lo
	Humidity>90%	HI
	Temperature<0°C or >60°C	---

## TO SET THE VISUAL ANGLE

User can use <▲/▲> slide switch to set visual angle:

If the clock is placed directly on a flat surface with the table stand, choose the <▲> position.

If the clock is hanged on the wall with the wall mounting hole, choose the <▲> position.

The above right choice ensures high definition of visual angle for the liquid display.

## BATTERY REPLACEMENT

When the low battery indicator “” displays, it indicates that the battery power is not enough. You should replace with 4 AA size batteries at once.

### NOTE:

- If the clock is not used for a long time, please take off the batteries.
- Attention! Batteries should not be exposed to excessive heat such as sunshine, fire or the like. Please dispose of used unit or batteries in an ecologically safe manner.



## SPECIFICATIONS

Radio controlled signal: DCF77/MSF/WWVB/JJY

### TEMPERATURE

Display range: -40°C~70°C (-40°F~158°F)

Operating range: 0°C~45°C (32°F~113°F)

### Accuracy:

-5°C~-0.1°C:	+/-2°C
0°C~40°C:	+/-1°C
40.1°C~50°C:	+/-2°C
(23°F~32°F:	+/-4°F
33°F~86°F:	+/-2°F
87°F~122°F:	+/-4°F)

### HUMIDITY

Display range: 20%~90%

### Accuracy:

20% RH~40% RH:	+/-7% RH
41% RH~70% RH:	+/-5% RH
71% RH~90% RH:	+/-7% RH

### POWER

4 x AA size 1.5V batteries (Alkaline recommended)

### DIMENSION

224(L) x 224(H) x 23(D) mm

## WARRANTY, SERVICE, OR RECALIBRATION

For warranty, service, or recalibration, contact:

### TRACEABLE® PRODUCTS

12554 Old Galveston Rd. Suite B230

Webster, Texas 77598 USA

Ph. 281 482-1714 • Fax 281 482-9448

E-mail support@traceable.com • www.traceable.com

Traceable® Products is ISO 9001:2015 Quality-

Certified by DNV and ISO/IEC 17025:2005

accredited as a Calibration Laboratory by A2LA.

**TRACEABLE®**  
**ATOMIC CLOCK**  
**WITH**  
**TEMPERATURE**  
**& HUMIDITY**  
**INSTRUCTIONS**

Cat. No. 1076

Traceable® is a registered trademark of Cole-Parmer.

©2018 Traceable® Products. 92-1086-00 Rev. 0 041318